

Innovation
Ingenuity
Excellence

IDEM

Providing Machine Safety for YOU at Work



SIÈGE SOCIAL - FACTURATION
Fax 02 99 44 19 59
Le Bois Régnier
35150 CHANTELOUP

NEGOSPHERE 35
Tél. 02 99 44 15 24
negosphere35@negosphere.fr

AGENCE COMMERCIALE
Fax 02 72 88 25 67
2 allée de la Vilaine - Z.A. Château Gaillard IV
35470 BAIN DE BRETAGNE

RCS RENNES 500248711 - SIRET : 50024871100011 - Code APE : 4652Z - TVA Intracommunautaire : FR72500248711 - SARL au capital de 20 000 €



www.negosphere.fr

IP69K Stainless Steel Safety Interlock Switches

- Designed specifically for Food Processing, Packaging, Pharmaceutical and Petro-Chemical Industries •
- Suitable for CIP/SIP Cleaning • Fully Stainless Steel • IP69K and IP67 • Tested to 80C and 80 bar chemical washdown •

HYGIECAM MK1-SS



Compact with 22mm fixing centres. Mirror polished finish. Suitable for most applications. Small 30mm wide x 99mm long. Replaceable contact blocks. Provides 8 actuator entry points. Standard or flexible actuator.

HYGIECAM K-SS



Universal Fitting - established footprint. Suitable for most general applications. 52mm wide x 99mm long. Replaceable contact blocks. Head rotates to give 4 actuator entry points. Standard or flexible actuator options.

HYGIECAM KM-SS



Slim fitting suitable for most industrial applications. Mirror polished surface finish (Ra4). 42mm wide x 118mm long. Head rotates to protect head assembly and prevent tampering with switch. Provides 8 actuator entry positions.



K-SS-Ex



KM-SS-Ex

- Exd IIC T6 (-20 ≤ Ta ≤ +60C) Gb
- Ex tb IIIC T85C (-20 ≤ Ta ≤ +60C) Db

RYANLOCK KL1-SS



Solenoid locking. Provides 4 actuator entry points. Rotatable head. Compact 63mm wide x 143mm long. 2 lock monitoring safety contacts. LED 1: Status of solenoid applied power. LED 2: Status of guard lock.

HYGIELOCK KL3-SS



Solenoid locking. Power solenoid to unlock. Choice of 24V 110V or 230V operation. Slim body 48mm wide x 177mm long. Suitable for all industry applications. 2 LEDs for solenoid and lock status. Standard or flexible actuator options available.

HYGIELOCK KLT-SS



Solenoid locking. Integral high security RFID (unique or master coding). Mirror polished finish (Ra10) Stainless Steel 316. Will fit on 73mm fixing centres. M23 Quick Connector available for ease of installation. 2 manual override points. LED diagnostics for Solenoid, Lock and faults.

Stainless Steel 316 Grab Wire Safety Rope Switches

GLHL-SS



GLHD-SS



GLHR-SS



The Guardian Line range of switches in Stainless Steel 316 housings has been designed as a Heavy Duty Rope Pull switch system to protect long conveyors up to 250m with just one switch. Distances up to 5km can be covered by connecting multiple switches together. The fixing holes are under the cover of the switch to prevent food trap and contamination areas. ATEX explosion proof versions are available (see below).

GLS-SS

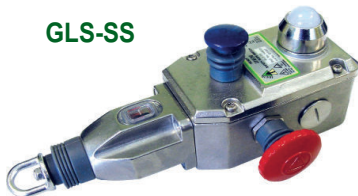

The GLS-SS is a general duty Stainless Steel grab wire safety rope switch designed to protect conveyor lengths up to 80m using just one safety rope switch.

GLM-SS



The GLM-SS is the latest addition to the range. A medium duty Stainless Steel grab wire safety rope switch designed to protect conveyor lengths up to 30m using just one safety rope switch



Stainless Steel 316 Rope Switches - ATEX models



GLS-SS-Ex



Exd IIC T6 (-20 ≤ Ta ≤ +60C) Gb

GLHL-SS-Ex



Ex tb IIIC T85C (-20 ≤ Ta ≤ +60C) Db

GLHD-SS-Ex



GLHR-SS-Ex

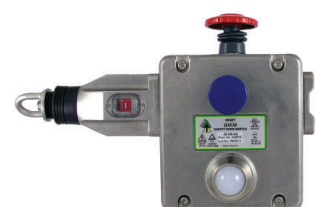

IP69K Stainless Steel 316 Non Contact Interlock Switches

HYGIECODE and HYGIEMAG RANGE

- Operates in temperatures up to 105C • Suitable for CIP/SIP high-pressure cleaning • IP69K or IP67 •
- Operates with most Safety Relays to achieve up to PLe/Cat.4 (ISO13849-1) •

HYGIECODE Versions: Coded Actuation • Solid State Parts • Survives Shock and Vibration • LED Indication

HYGIEMAG Versions: High Power Magnetic Sensing • Up to 1A Current Switching

MMC-H and MMR-H



Miniature fitting with industry standard 22mm fixing.
M4 clearance holes - suitable for mounting with hexagonal head bolts.
Coded Switch sensing: 10mm.
Magnetic Switch sensing: 10mm.
Suitable for food splash/contact zones.

SMC and SMR



Small stainless steel 316 housing.
Compact 50mm long with 22mm fixing hole centres.
Coded Switch sensing: 14mm.
Magnetic Switch sensing: 12mm.
Suitable for food splash zones.

SMC-F and SMR-F



Small stainless steel 316 hygienic housing.
Rear fixing holes no visible food traps.
Compact 50mm long with 22mm fixing hole centres.
Coded Switch sensing: 14mm.
Magnetic Switch sensing: 12mm.
Suitable for food splash/contact zones.

SMC-H and SMR-H



Small S/Steel 316 hygienic housing.
Can be mounted with hexagonal head bolts to prevent food traps.
Universal fitting 22mm fixing.
Coded Switch sensing: 14mm.
Magnetic Switch sensing: 12mm.
Suitable for food splash/contact zones.

LMC and LMR



Slim fitting with a narrow profile for flush mounting.
Can be mounted unobtrusively.
Mirror polished finish.
88mm long x 25mm wide.
Coded Switch sensing: 14mm.
Magnetic Switch sensing: 12mm.
Suitable for food splash zones.

CMC and CMR



Compact stainless steel 316 hygienic fitting.
Slim fitting 20mm wide - can be fitted in narrow channels.
Coded Switch sensing: 14mm.
Magnetic Switch sensing: 12mm.
Suitable for food splash zones.

CMC-F and CMR-F



Compact and narrow.
Mounting holes at the rear - no food trap areas.
Slim fitting 20mm wide can be fitted in narrow channels.
Coded Switch sensing: 14mm
Magnetic Switch sensing: 12mm
Suitable for food splash/contact zones.

WMC and WMR



Robust 32mm wide housing.
High tolerance to misalignment.
Stainless steel housing with mirror polished finish.
Coded Switch sensing: 14mm.
Magnetic Switch sensing: 12mm.
Suitable for food splash zones.

RMC and RMR



Barrel type cylindrical fitting with M30 thread.
45mm adjustment length.
Easy to install and set.
Suitable for all applications.
Coded Switch sensing: 10mm.
Magnetic Switch sensing: 10mm.
Suitable for some food contact zones.

Non Contact Explosion Proof Safety Switches in Stainless Steel 316



WM1-Ex



WM2-Ex



CM1-Ex



CM3-Ex



RM-Ex

- Ex II 1G Ex ma IIC T6 Ga
- Ex II 1D Ex ma IIIC T80 Da IP67*

- Ex II 2G Ex mb IIC T6 Gb
- Ex II 2D Ex mb IIIC T80 Db IP67*



- Ex II 2G Ex mb IIC T6 Gb
- Ex II 2D Ex mb IIIC T80 Db IP67*



CM2-Ex



LM-Ex

CM1-Ex CM2-Ex CM3-Ex RM-Ex LM-Ex
Zones 1, 21, 2, 22
Gas and Dust

Zones 0, 20, 1, 21, 2, 22
Gas and Dust

Zones 1, 21, 2, 22
Gas and Dust

Plastic Non Contact Safety Switches

IDECODE and IDEMAG RANGE

- Industry established universal fittings - suitable for all applications ●
- Specified to work up to 80C ● IP67 or IP69K ● High specification plastic housings ●
- Operates with most Safety Relays to achieve up to PLe/Cat.4 (ISO13849-1) ●

IDECODE Versions:

- Coded Actuation ● Solid State Parts
- Survives Shock and Vibration
- High Tolerance to Guard Misalignment

MPC



MINIATURE FITTING:

Miniature fitting - suitable for all small guarding applications. Cable exit left or right options available. Supplied with hygienic screw cap covers. Sensing: 10mm.

SPC



SMALL FITTING:

Universal fitting with an established industry footprint - suitable for most general industry applications. Withstands environments of high humidity and wash down conditions. Sensing: 14mm.

LPC



EURO FITTING:

Popular European fitting suitable for all industry applications. Narrow fitting for flush mounting. Unique long life high power switching. Suitable for high pressure hosing IP69K. Sensing: 14mm.

CPC



COMPACT FITTING:

Slim design - suitable for all industry applications. Easy to install within narrow frame sections - can be installed unobtrusively. Suitable for high pressure hosing IP69K. Sensing: 14mm.

WPC



WIDE FITTING:

Suitable for all industry applications. LED indication. No moving parts - survives shock and vibration. Suitable for high pressure hosing IP69K. Sensing: 14mm.

RPC

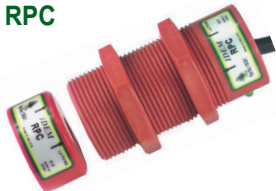

M30 CYLINDRICAL FITTING:

Suitable for all industry applications. Easy to install - M30 threaded body and easy to set. 45mm adjustment length. Suitable for high pressure hosing IP69K. Sensing: 10mm.

IDEMAG Versions:

- High Power Magnetic Sensing
- Up to 1A Current Switching
- High Tolerance to Guard Misalignment

MPR



MINIATURE FITTING:

Miniature fitting - suitable for all small guarding applications. Cable exit left or right options available. Supplied with hygienic screw cap covers. Sensing: 12mm.

SPR



SMALL FITTING:

Universal fitting with an established industry footprint - suitable for most general industry applications. Withstands environments of high humidity and wash down conditions. Sensing: 12mm.

LPR



EURO FITTING:

Popular European fitting suitable for all industry applications. Narrow fitting for flush mounting. Unique long life high power switching. Suitable for high pressure hosing IP69K. Sensing: 12mm. Available with LED if required.

CPR



COMPACT FITTING:

Slim design - suitable for all industry applications. Easy to install within narrow frame sections - can be installed unobtrusively. Suitable for high pressure hosing IP69K. Sensing: 12mm.

WPR



WIDE FITTING:

Suitable for all industry applications. No moving parts - survives shock and vibration. Suitable for high pressure hosing with IP69K ingress protection. Sensing: 12mm.

RPR

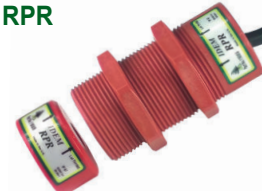

M30 CYLINDRICAL FITTING:

Suitable for all industry applications. Easy to install - M30 threaded body and easy to set. 45mm adjustment length. Suitable for high pressure hosing IP69K. Sensing: 10mm.

Gate Bolts for Non Contact Switches



Type: GBN-1

Suitable for:

Coded type switches:
SPC, SMC, SMC-H, LPC, LMC.

Magnetic type switches:
SPR, SMR, SMR-H, LPR, LMR.

RFID type switches:
SPF-RFID, LPF-RFID and LPZ-RFID.

Stainless Steel Guide



Type: GBN-3

Suitable for:

Coded type switches:
SPC, SMC, SMC-H, LPC, LMC.

Magnetic type switches:
SPR, SMR, SMR-H, LPR, LMR.

RFID type switches:
SPF-RFID, LPF-RFID and LPZ-RFID.

Spring Loaded Stainless Steel Latch.

The door latch is held magnetically in the GBN-3 Gate Bolt. A push or pull operation is required to release.

Tongue Interlock Safety Switches

Mechanical Interlock Switches

INCH-1



Miniature plastic housing:
25mm x 55mm with 17mm fixing centres.
8 Actuator entry positions - designed with a rotatable Stainless Steel 316 head.
2 pole contact blocks.
IP67 ingress protection.

INCH-3



8 Actuator entry positions - designed with a rotatable Stainless Steel 316 head.
3 pole contact blocks.
Choice of 3 conduit entries.
Plastic housing with IP67 ingress protection.
25mm wide 79mm long 22mm fixing.

IDIS-1



Compact yet robust fitting suitable for all small guard applications. Suitable for food processing and petro-chemical industries.
8 Actuator entry positions - rotatable head.
3 pole contact blocks or 2 pole snap action.
32mm wide 97mm long 17mm fixing.

K-15



4 Actuator entry positions - designed with a rotatable head.
Compact body with 3 conduit entries.
3 pole contact blocks.
54mm wide 86mm long 40mm fixing.
Plastic or Stainless Steel 316 head options.
IP67 ingress protection rating

KP



4 Actuator entry positions - designed with a rotatable head.
3 pole or 4 pole contact blocks.
3 conduit entries.
52mm wide 98mm long 40mm fixing.
Plastic or Stainless Steel 316 head options.
IP67 ingress protection rating.

EX ALSO AVAILABLE IN EXPLOSION PROOF VERSION

KM



Robust die cast housing. Slim fitting designed for where impact resistance is required.
Available with die cast or stainless steel head.
8 Actuator entry positions - rotatable head.
3 pole or 4 pole contact blocks.
40mm x 118mm lx 30mm fixing. IP67 ingress protection.

EX ALSO AVAILABLE IN EXPLOSION PROOF VERSION

Mechanical Interlock Switches with Solenoid Guard Locking

KL1-P



Small plastic body with universal 40mm mounting.
4 Actuator entry positions - rotatable head.
Guard locking for small to medium guard doors.
Solenoid locking.
Stainless steel head for robustness - suitable for most industrial applications.
63mm wide 143mm long 40mm fixing.

KLP



Compact plastic body/stainless steel head locking switch for medium to heavy duty guards.
Provides 2NC safety contacts and 2NO auxiliary contacts or LED indication diagnostics.
8 Actuator entry positions - rotatable head.
Solenoid locking.
46mm wide 160mm long 30mm fixing.

KLM



Die cast metal switch suitable for heavy duty guard locking with solenoid locking
Provides 4NC safety contacts and 2NO auxiliary contacts or LED indication diagnostics.
The 3 conduit entry points and 30mm fixing provide maximum flexibility on all applications.
46mm wide 176mm long 30mm fixing.

KLTM-RFID



ALSO AVAILABLE AS MECHANICAL ONLY- KLTM

Integral high security RFID coded die-cast metal locking safety switch with solenoid locking.
Traditional tongue type interlock with added RFID sensor for unique actuator coding.
Exceptionally rugged and solid body with 2 lock monitoring safety contacts.
105mm wide 150mm long 73mm fixing.

P2L Versions (Power to Lock)

P2L (Power to Lock) VERSIONS
(For machines without rundown time.)

KLP-P2L



KLM-P2L



AVAILABLE WITH DIE-CAST OR S/STEEL HEAD

KLTM-P2L



RR Versions (Rear Release)

A manual escape release is provided to enable quick release of the switch lock in case of emergency.

KLM-RR



KLTM-RFID-RR



Mechanical Hinge Interlock Safety Switches

HC-1



Plastic bodied.
Stainless steel head.
Fits to the hinged axis of small guard doors.
Available with solid stainless steel shafts or hollow shafts.
2 safety contacts.
2NC or 1NC 1NO.
25mm wide
77mm long
18mm fixing.

HC-3



Plastic bodied.
Stainless steel head.
Fits to the hinged axis of medium sized guard doors.
Available with solid stainless steel shafts or hollow shafts.
2NC 1NO contacts.
25mm wide
103mm long
18mm fixing.

HC-SS



Fully Stainless Steel
316 body and head.
Robust hinge cam for fixing to the hinged axis of guard doors.
Available with solid stainless steel shafts or hollow shafts.
2NC 1NO contacts.
20mm wide
98mm long
22mm fixing.

IDIS-2



Plastic body with Stainless Steel actuator.
Designed to fit to hinged axis of guard doors.
Available with 2NC 1NO, 3NC or 1NC 1NO snap action contacts
31.5mm wide
65mm long (exc. actuator)
22mm fixing.

RFID and StandAlone Non Contact Safety Switches

SPF



LPF



LPZ



Non Contact RFID with Unique or Series Coding.

Designed to provide high security on guard doors.
Diagnostic LED - indication of safety circuits closed.
Connect up to 20 switches in series.
Connect to other switches and E-Stops in series

High functional safety to ISO13849-1.
Connects to most safety relays.
2NC safety outputs.
1NO auxiliary output for indication.

RAMZSense RFID with Unique or Series Coding

Provides high security on guard doors.
Maintains PLe/Cat.4 to ISO13849-1 even with switches connected in series. Connect up to 20 switches in series.
Connect to other switches/E Stops.

PSA



MSA



StandAlone Coded Non Contact Safety Interlock Switches

Standalone switches for direct machine control.
Diagnostic LED - indicates safety circuits closed.
Compact housing - fits on 40mm frame sections.
Maintains PLe/Cat.4 to ISO13849-1.
2NC Relay safety outputs - high current switching 3A
Available in Plastic or Stainless Steel housings (IP69K).
Connect up to 20 switches in series.
Able to connect other switches and E Stops in series.
Contact feedback circuit (manual or auto).
Auxiliary output for indication of door open.



IDEM VIPER Series SCR-i Safety Relays



SCR-21-i



SCR-31-i



SCR-31P-i

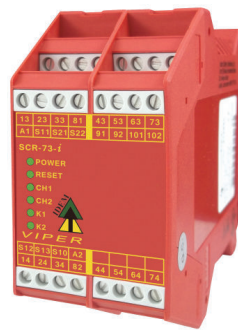

SCR-73-i

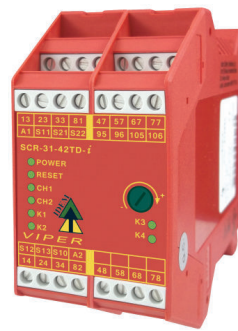

SCR-31-42TD-i



SEU-31-i



SEU-31TD-i

FEATURES:

- Dual force guided relay output contacts with high current outputs up to 6A.
- Up to PLe/Cat.4 to ISO13849-1 and SIL3 to EN62061.
- Single or dual channel input.
- Feedback loop for monitoring contactors.
- Short circuit and earth fault monitoring.
- Automatic or manual start. Monitored manual.
- Instant or delayed contacts.

LED DIAGNOSTIC FEATURES:

All relays include a combination of the below diagnostics. (See full catalogue)

Power	Power applied to device
Reset	Reset Circuit is closed
CH1	External switch input 1 closed
CH2	External switch input 2 closed
K1	Internal relay safety output contacts closed
K2	Internal relay safety output contacts closed
K3	Internal relay safety output contacts closed
K4	Internal relay safety output contacts closed

VIPER SCR-i PRODUCT SELECTION CHART

	Supply Voltage	Manual/Automatic Reset	Single/Dual Channel	Instant Output Contacts	Time Delay Output Contacts	Time Delay Range	Diagnostic LEDs	Housing Width (mm)	ISO13849-1 PL (up to)	EN62061 SIL (up to)
Base Units										
SCR-21-i	24V dc/ac	M or A	S or D	2NC 1NO	-	-	6	22.5	PLe	SIL3
SCR-31-i	24V dc/ac	M or A	S or D	3NC 1NO	-	-	6	22.5	PLe	SIL3
SCR-31P-i	24V dc/ac	M or A	S or D	3NC 1NO	-	-	6	22.5	PLe	SIL3
SCR-73-i	24V dc/ac	M or A	S or D	7NC 3NO	-	-	6	45.0	PLe	SIL3
SCR-31-42TD-i	24V dc/ac	M or A	S or D	3NC 1NO	4NC 2NO	0 to 30 secs	8	45.0	PLe/PLd	SIL3/SIL2
Expansion Units (these can be slave wired to any base unit to increase the output contacts)										
SEU-31-i	24V dc/ac	M or A	N/A	3NC 1NO	-	-	3	22.5	PLe	SIL3
SEU-31TD-i	24V dc/ac	M or A	N/A	-	3NC 1NO	0 to 30 secs	3	22.5	SIL3/SIL2	SIL3/SIL2

Notes:
NC contacts are closed when safety relay is energised - machine is able to start.
NO contacts are closed when safety relay is de-energised - machine stopped or stopping

SKORPION Trapped Key Interlocking with Key Exchange

AVAILABLE IN STAINLESS STEEL 316 OR DIE-CAST (Mirror Polished Finish)



ISOLATION

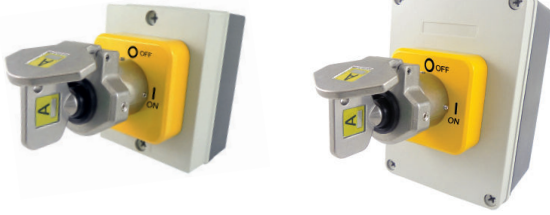

ISB1
Available with Stainless Steel or Die-Cast Key Barrel.
25A 660V 4-Pole
40A 660V 4-Pole

ISB2
Available with Stainless Steel or Die-Cast Key Barrel.
63A 660V 4-Pole
100A 660V 4-Pole

ISP
Available in Stainless Steel or Die-Cast.
63A 660V 4-Pole
100A 660V 4-Pole

KEY EXCHANGE SYSTEM

SS-KE-NS4



KEY EXCHANGE SYSTEM

Available in Stainless Steel or Die-Cast.
Currently available with:
1 Key Trapped and up to 5 Keys Released (non-sequential)

BOLT INTERLOCKS (not suitable for guard access) - available in Stainless Steel 316 or Die-Cast with Mirror Polished Finish

SS-BS

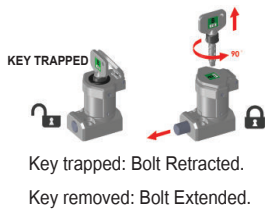

Key trapped: Bolt Retracted.
Key removed: Bolt Extended.

SS-BD-11

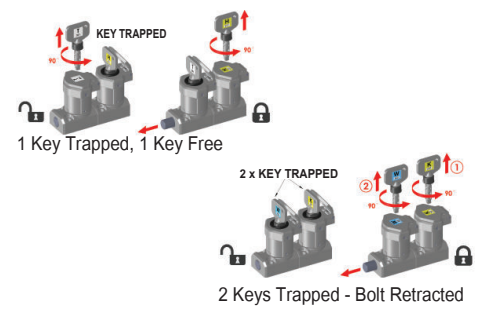

1 Key Trapped, 1 Key Free

2 x KEY TRAPPED
2 Keys Trapped - Bolt Retracted

HANDLE INTERLOCKS (Single Key) - available in Stainless Steel 316 or Die-Cast with Mirror Polished Finish

M-HS

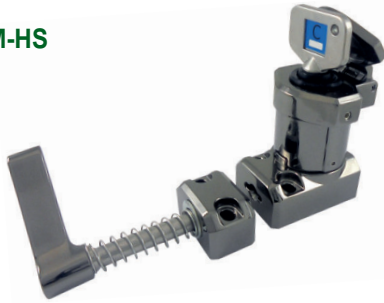

M-HS-C

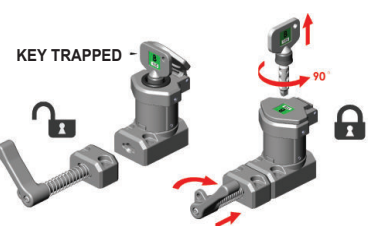

Key trapped: Actuator (handle) unlocked.
Key removed: Actuator (handle) locked in position.

HANDLE INTERLOCKS (Dual Key) - available in Stainless Steel 316 or Die-Cast with Mirror Polished Finish

M-HD-11



M-HD-C-11

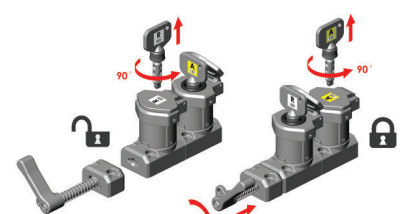

1 Key Trapped, 1 Key Free - Actuator unlocked.

TONGUE INTERLOCKS (Single Key)

M-TS

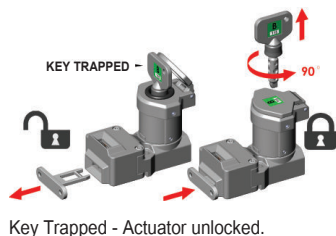

Key Trapped - Actuator unlocked.

Various actuator options.

TONGUE INTERLOCKS (Dual Key)

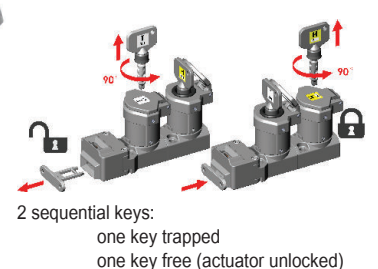

2 sequential keys:
one key trapped
one key free (actuator unlocked)

Various actuator options.

SKORPION Trapped Key Interlocking with Key Exchange

AVAILABLE IN STAINLESS STEEL 316 OR DIE-CAST (Mirror Polished Finish)



INTERLOCKING WITH CONTROL ISOLATION

SS-TS-CB



Various actuator options.

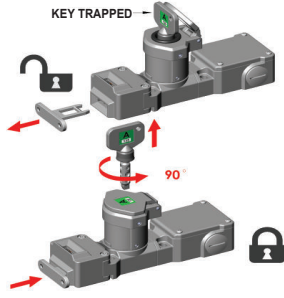

TONGUE INTERLOCK SINGLE KEY WITH CONTACT BLOCK Available in STAINLESS STEEL 316 or DIE CAST with Mirror Polished Finish
Single Tongue Interlock with 2NC 2NO Contact Block - 1/2" NPT
Single Tongue Interlock with 3NC 1NO Contact Block - 1/2" NPT
Single Tongue Interlock with 2NC 2NO Contact Block - M20
Single Tongue Interlock with 3NC 1NO Contact Block - M20

EXPLOSION PROOF INTERLOCKING WITH CONTROL ISOLATION - Stainless Steel 316 or Die Cast (Mirror Polished Finish)

SS-TS-CB-EX

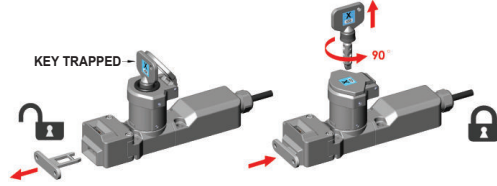

TONGUE INTERLOCK SINGLE KEY WITH EXPLOSION PROOF CONTACT BLOCK Available in STAINLESS STEEL 316 or DIE CAST with Mirror Polished Finish
Single Tongue Interlock with 2NC 2NO Pre-wired EX Block
Single Tongue Interlock with 1NC 1NO Pre-wired EX Block



Trapped Key with ATEX EExd IIC T6 certified explosion proof contact blocks. The explosion proof contact blocks conform to European harmonized standard EN60079-0 and EN60079-1 and can be used in European Zone 1, 2, 21, 22 environments. (Gas and Dust). Adheres to the latest standard ISO13850, Designed for use in oil, petro-chemical, pharmaceutical, food processing and packaging applications where the potential for explosive atmospheres are present.

- Exd IIC T6 (-20 ≤ Ta ≤ +60C)
- Ex tb IIIC T85C (-20 ≤ Ta ≤ +60C) Db

PYTHON Belt Alignment Switches

AVAILABLE IN STAINLESS STEEL 316 OR DIE-CAST



- Available with M20 and 1/2" NPT fixing.
- 24V, 110V and 230V models.
- 35mm Short Roller
- 35mm Long Roller
- 50mm Roller

- EXPLOSION PROOF option also available on ALL models



- Exd IIC T6 (-20 ≤ Ta ≤ +60C)
- Ex tb IIIC T85C (-20 ≤ Ta ≤ +60C) Db



Belt Switch 35mm Roller Short Die Cast



Belt Switch 50mm Roller Die Cast



Belt Switch 35mm Roller Long Die Cast



Belt Switch 35mm Roller Short Stainless Steel

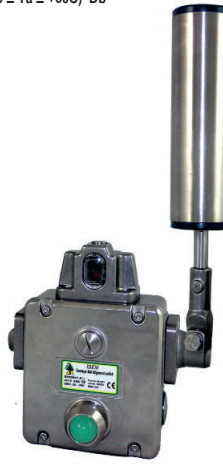

Belt Switch 50mm Roller Stainless Steel



Belt Switch 35mm Roller Long Stainless Steel

Gate Bolts for Interlock Switches



Available in Stainless Steel or Die Cast Aluminium

BISON Solenoid Locking & RFID Gate Bolt with Multi-Functions



Type: GBL-1
Shown fitted with KLM switch. For solenoid locking tongue switches with optional extra rear handle. Suitable for: KLP, KLM, KLM-RR and KL4-SS.

Type: GBA-1
Suitable for KM tongue interlock switch.

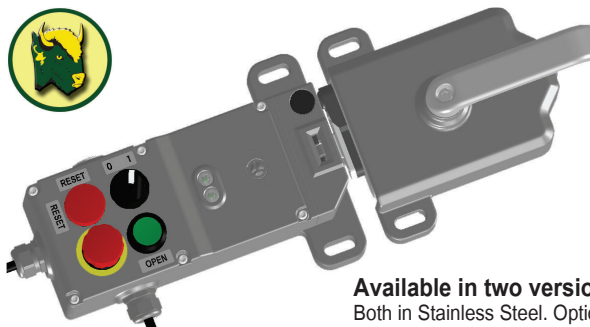

Type: BISON
Solenoid locking gate bolt switch holds up to 2000N. Also fitted with RFID to prevent anti-tamper and provide an extra level of safety. Various actuators and lock options available.

Available in two versions:
Both in Stainless Steel. Options of LED indication, I/O button, request button and emergency stop button.
Version 1: Any combination of above four options.
Version 2: Combination of any two of the above four options.

Guardian Line Series - Grab Wire Safety Rope Switches



GLHL



GLHD



GLHR

Designed in heavy duty robust die-cast metal and able to survive external or internal use the Guardian Line Range has the ability to protect conveyors up to 200m with just one switch (GLHD). Distances up to 2km can be achieved by connecting less than 20 switches. A 2-colour LED ensures switch status can be seen easily from a distance. LED status: Steady Green with Flashing Red (Stop) or Steady Green with Steady Red (Stop). The GLHL or GLHR can be used for lengths up to 100m using just one switch, or can be used to complement the GLHD version at each end of the rope span. The fixing holes are under the cover of the switch to prevent food trap and contamination areas.

Enclosure/Cover: Die-cast painted yellow
 IP Rating: IP67
 Ambient Temp.: -25C to +80C
 Operating Force: <125N <300mm Deflection
 Mechanical Life: 1,500,000 operations
 Operational Rating: AC15 A300 240V 3A
 Contacts: 4NC 2NO

GLM



Designed as a light duty switch the compact GLM is an extremely popular solution which is able to protect short conveyor lengths in most industrial applications. Up to 50m can be protected using two switches or with a single switch distances up to 30m can be protected. The GLM provides a reliable and cost effective safety solution for the shorter conveyor systems and has optional E-Stop and 2-colour LED to show switch status.

Enclosure/Cover: Die-cast painted yellow
 IP Rating: IP67
 Ambient Temp.: -25C to +80C
 Operating Force: <125N <300mm Deflection
 Mechanical Life: 1,500,000 operations
 Operational Rating: AC15 A300 240V 3A
 Contact Options: 2NC/1NO 3NC/1NO 2NC/2NO 4NC

GLS



The GLS has been designed as a standard general duty switch to protect conveyor lengths where protection is required up to 80m (using two switches) or up to 60m (using a single switch). They are supplied complete with a mushroom type E-Stop which can be fitted (with no extra wiring) to the side of the switch to offer an extra traditional E-Stop function close to the switch.

Enclosure/Cover: Die-cast painted yellow
 IP Rating: IP67
 Ambient Temp.: -25C to +80C
 Operating Force: <125N <300mm Deflection
 Mechanical Life: 1,500,000 operations
 Operational Rating: AC15 A300 240V 3A
 Contacts: 4NC 2NO

Explosion Proof Versions

GLS-Ex



GLHD-Ex



Exd IIC T6 (-20 ≤ Ta ≤ +60C) Gb
 Ex tb IIIC T85C (-20 ≤ Ta ≤ +60C) Db



IDEM Patented Tensioner/Gripper System and Rope System Accessories

RELIABLE CONNECTIVITY: Tensioning of the rope is achieved by the use of IDEM's patented Tensioner/Gripper accessory. Traditional clamp systems are difficult to tension and adjust and frequent re-tensioning or maintenance is often required.



Rope Kits up to 126m. Contains Rope, Eyebolts and Tensioner/Gripper.

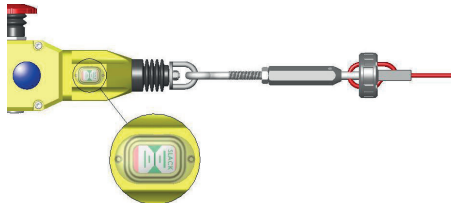

The Tensioner thimble allows immediate, accurate and final tensioning of the rope, whilst viewing the tension marker through the viewing window of the rope switch.

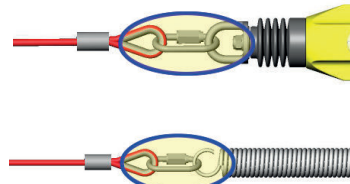

For systems up to 50m a Quick Link clamp is provided at one end of the rope for easy connection to either a safety spring or switch eyebolt.



Stainless Steel Mounting Bracket
 Suitable for all IDEM Guardian Line Rope Safety Pull Switches.



Flexible Roller Eyebolt with Adjustment



Flexible Roller Eyebolt with Nuts no Adjustment



Pigtail Eyebolt
 Stainless Steel available in 114mm or 154mm length.

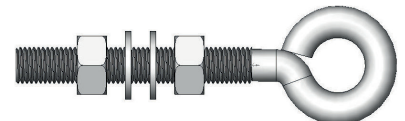

Standard Eyebolt
 Stainless Steel or Galvanised available in 84mm or 130mm length.

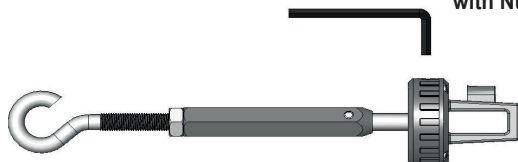

Rope Tensioner/Gripper Stainless Steel or Galvanised



Universal Pulley

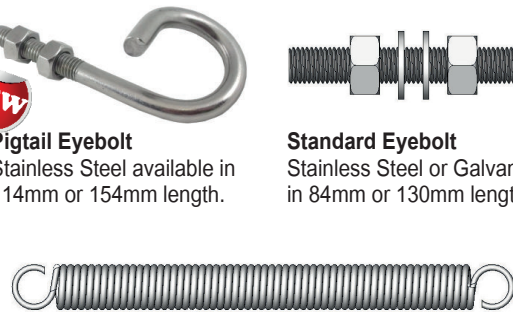

Safety Spring - Stainless Steel



LED-various options

MGL Non Contact RFID Locking Switch



MGL-1SS



MGL-1M



MGL-1P

Heavy Duty or Medium Duty holding force versions available.

Available in Stainless Steel 316 (with Stainless Magnet), robust Plastic or Die-Cast Metal.

Operates with most Safety Relays to achieve up to PLe/Cat.4 (ISO13849-1).

RFID Master Coded or Unique Coding.

The extremely popular MGL range of Non Contact RFID Coded switches has been developed in order to provide and maintain a high level of functional safety whilst providing a reliable magnetic door interlock. Flexibility for holding force is provided by the provision of 2 different switch sizes to cover all applications.

Safety Limit Switches in Stainless Steel, Die-Cast or Plastic Bodies

HLM-SS Stainless Steel IP69K EN50051



IP69K

- IEC60947-5-1 • EN50041 Housings
- Die Cast IP67 • Stainless Steel IP69K
 - AC15 A300 230V 3A
 - Rotary or Linear Actions
 - M20 or 1/2" NPT Entries
- High Mechanical Life - over 5 Million Operations
- 2NC 1NO • 3NC • 2NC 2NO • 3NC 1NO • 4NC

Explosion Proof Versions are available please see website or full catalogue.

Exd IIC T6 (-20 ≤ Ta ≤ +60C) Gb

Ex tb IIC T85C (-20 ≤ Ta ≤ +60C) Db



HLM Die-Cast Metal IP67 EN50051



LSPS Plastic Body EN50047



- IEC60947-5-1 EN50047 Polyester Housings
- Rotary or Linear Actions
- M20 or 1/2" NPT Entries
- High Mechanical Life - over 10 Million Operations
- AC15 A300 240V 3A
- 2NC 1NO • 3NC or 1NC 1NO Snap Block
- Side or Bottom Cable Exits

LSPM (Plastic Body) and LSMM (Die Cast Body)



- IEC60947-5-1 • Rotary or Linear Actions • M20 or 1/2" NPT
- High Mechanical Life • AC15 A300 240V 3A • -25C +80C

Micro Switches



To complement our range we now stock a wide range of the most popular micro switches including Pin Plunger, Roller Lever Panel Mount types, Short and Long Hinge Lever, etc. For the full range please consult the website or the full catalogue.



Emergency Stop Switches in Plastic, Die Cast and Stainless Steel



ESL-SS(P)

Stainless Steel IP69K • High Temperature Wash Down
2 or 3 Conduit Entries • 3 or 4 Pole Contacts
2NC 1NO 2NC 2NO or 3NC 1NO



ES-SS



ESL-SS(L)



ES-P

Plastic IP67
2 Conduit Entries
3NC or 2NC 1NO contacts



GLES



GLES-SS

4 Conduit Entries • 4NC 2NO Contacts
2 Colour LED • IP67/IP69K (S/Steel)
ATEX Explosion Proof versions available